



Best Practices for Testing Parallel Optics in the Enterprise

Benet Leong, VIAVI Solutions





Agenda

- Quick review of some basics and standards
- End-face inspection and certification
- Polarity Check / Fiber map
- Loss, Length and Polarity testing
- OTDR testing
- Wrap up



BASICS



Is MPO new?



**No – MPO connectors
and ribbon fiber have
been around for well over
a decade**





What's changed?

- Relentless need for speed
- MPO being extended to the equipment
 - Switches and Servers
 - QSFP ports

Current vs. Future Network Configurations				
	Enterprise Data Centers		Cloud Data Centers	
	SERVER	UPLINKS	SERVER	UPLINKS
Current Network Speeds	1G	10G	10G	40G
Future Network Speed Options	10G	40G	25G	100G
	OR		50G	200G
	10G	25G	100G	400G

Courtesy of Leviton





40/100GE Client Interfaces available today

Interface/Application	Reach	Medium	Parallelism	Standard
100GBASE-ER4	40 km	SMF	4 λ / dir	IEEE 802.3ba
ER4-Lite	20-25km	SMF	4 λ / dir	Variation on 802.3ba
100GBASE-LR4	10 km	SMF	4 λ / dir	IEEE 802.3ba
CWDM4	2 km	SMF	4 λ / dir	CWDM4 MSA
CLR4	2 km	SMF	4 λ / dir	CLR4 Alliance
PSM4	500 m	SMF	4 fibers / dir	PSM4 MSA
SWDM4	100 m	OM5 MMF	4 λ / dir	SWDM Alliance
40GBASE-SR4	100 m	OM4 MMF	4 fibers / dir	IEEE 802.3bj
100GBASE-SR4	70 m	OM4 MMF	4 fibers / dir	IEEE 802.3bm

Newer Data Center Interfaces:

SWDM4/SR4 100m

PSM4 500m

CWDM4 / CLR4 2km





Data Center Examples of MPO/Ribbon Fiber

6 x 1/10Gbps Ethernet Channels (MMF)

6 x 1/10Gbps Ethernet Channels (SMF)

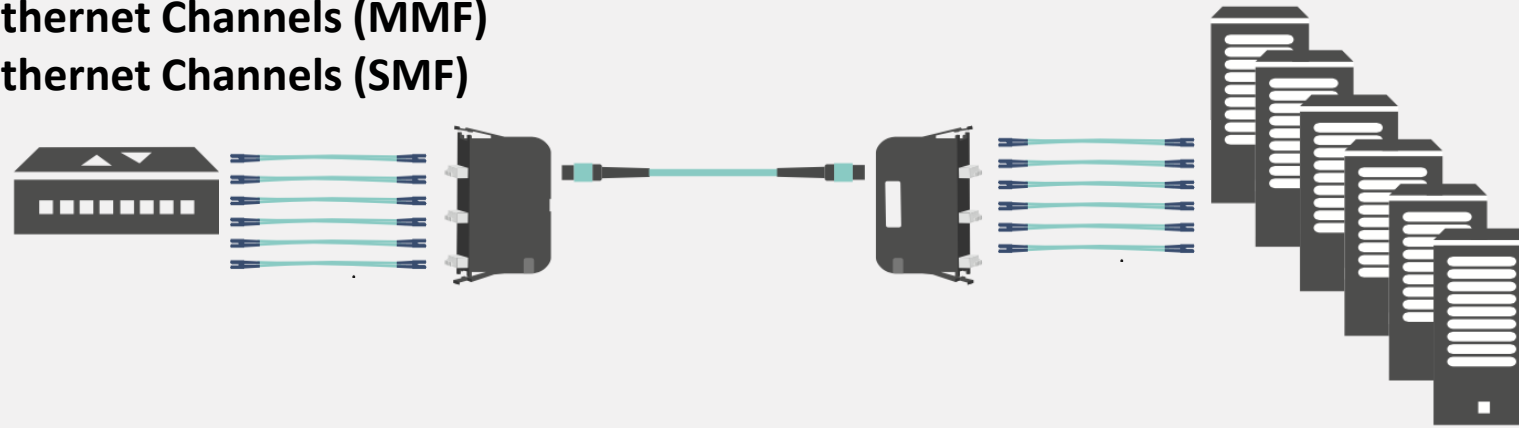

- Fiber consolidation and migration path
- SFP/SFP+ at each end
- 12 fiber MPO Link w/Cassettes at either end

4 x 10Gbps Ethernet Channels (MMF)

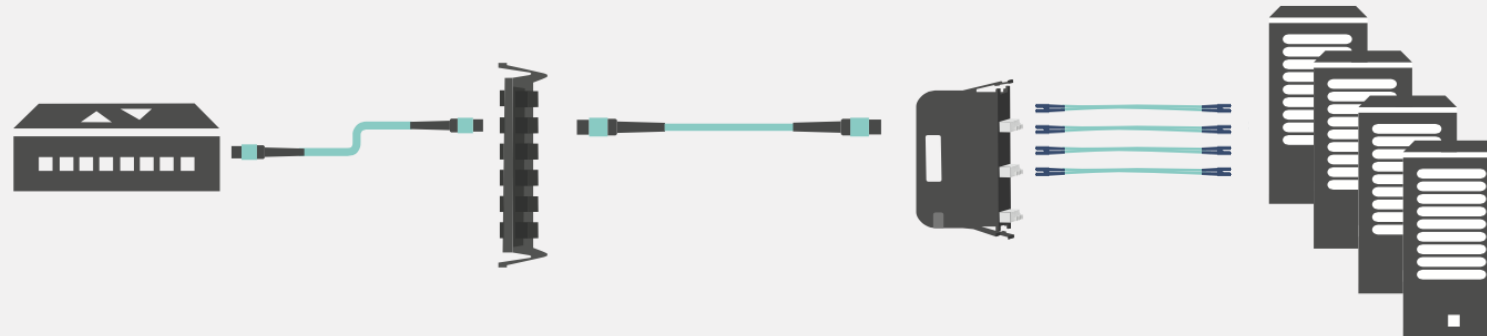

- 8 fiber MPO Link w/Cassette
- Fiber consolidation and migration path
- QSFP at switch SFP+ at server

40/100Gbps Ethernet Channels (MMF)

40/100Gbps Ethernet Channels (SMF – PSM4)

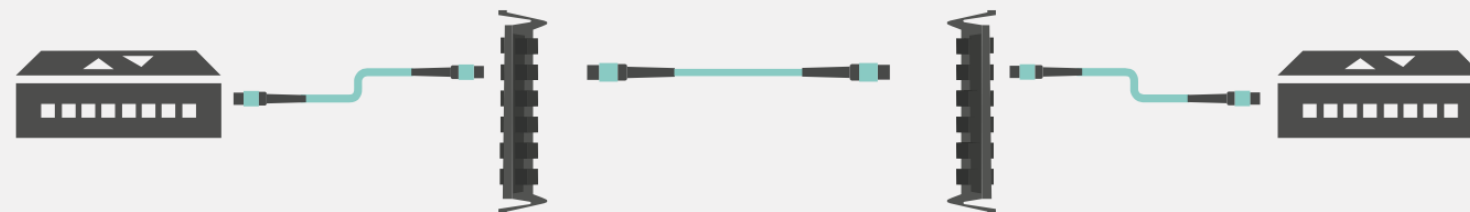

- 12 fiber MPO Link (8 fibers used)
- QSFP/CFP at both ends



Single Fiber vs. Multi-Fiber Connectors

SINGLE FIBER CONNECTOR

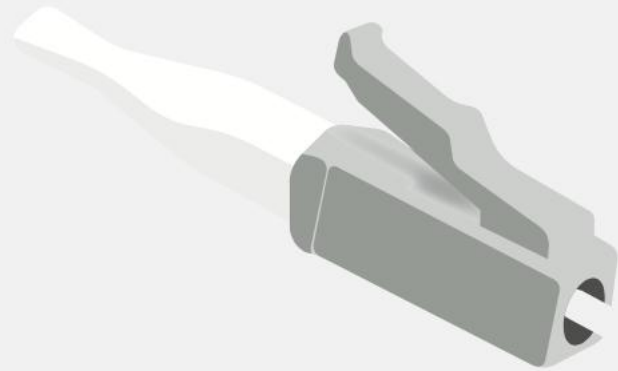

(example: LC)

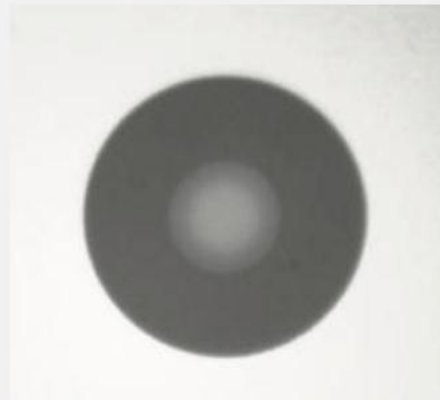

- **White ceramic ferrule**
- **One fiber per connector**
- **Common types include SC, LC, FC, and ST**

MULTI-FIBER CONNECTOR

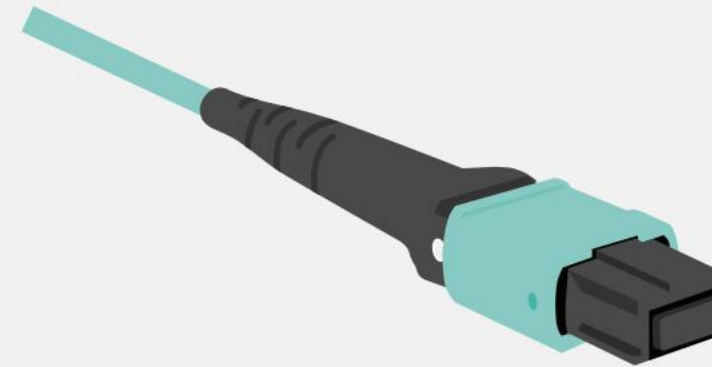

(example: MPO)

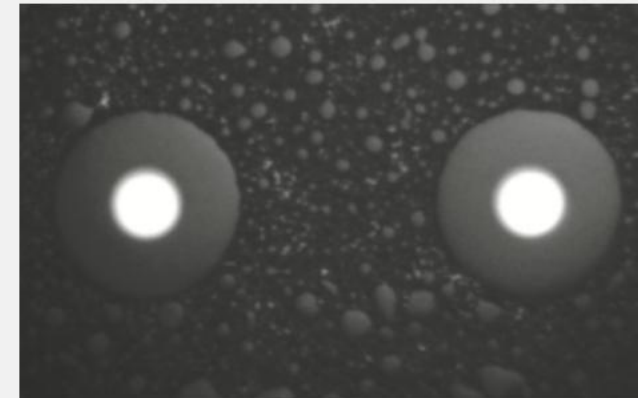

- **Polymer ferrule**
- **Multiple fibers in linear array**
(for example, 8, 12, 24, 48, and 72) in single connector providing high-density connectivity
- **Common type is MPO or MTP®**



Anatomy of a 12-fiber MPO Connector

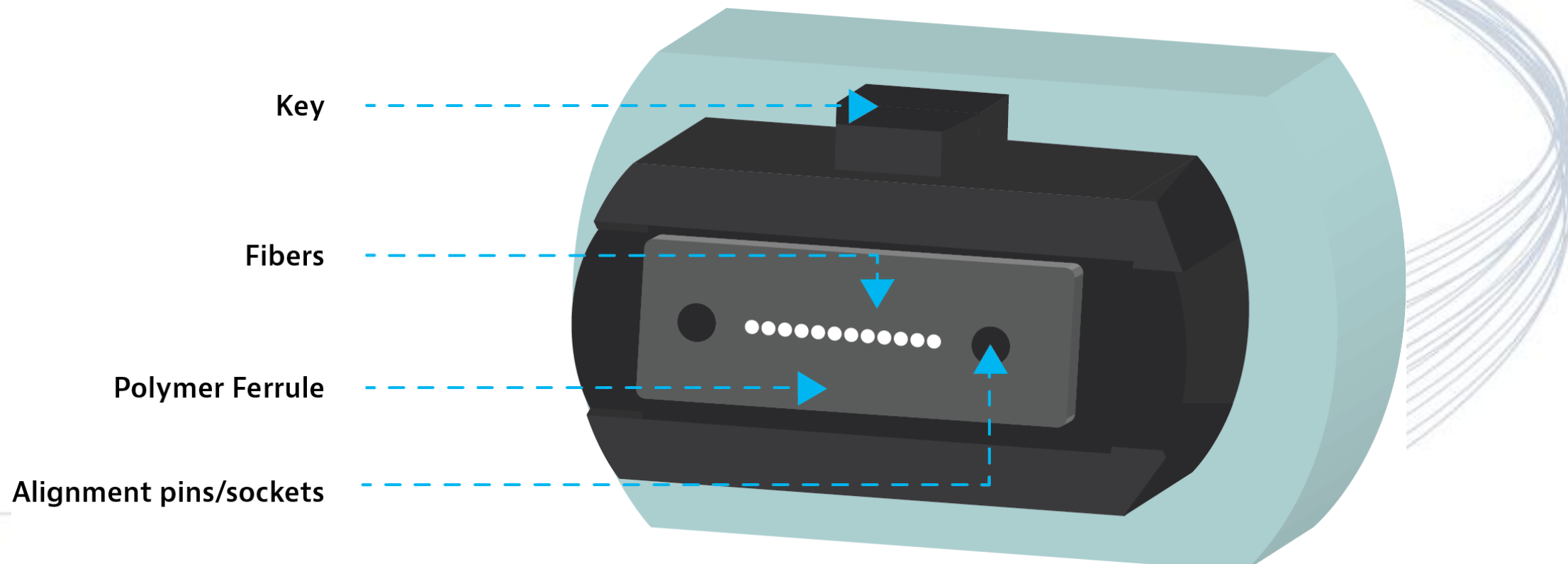

Note: MPO connectors with higher fiber counts (ie: 24) will have multiple rows of fiber on the ferrule

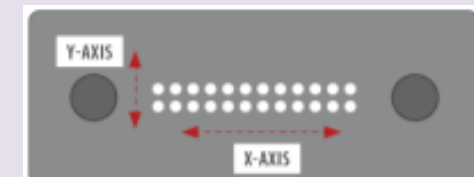



Polarity and Gender

TYPE "A" ADAPTER CONFIGURATION

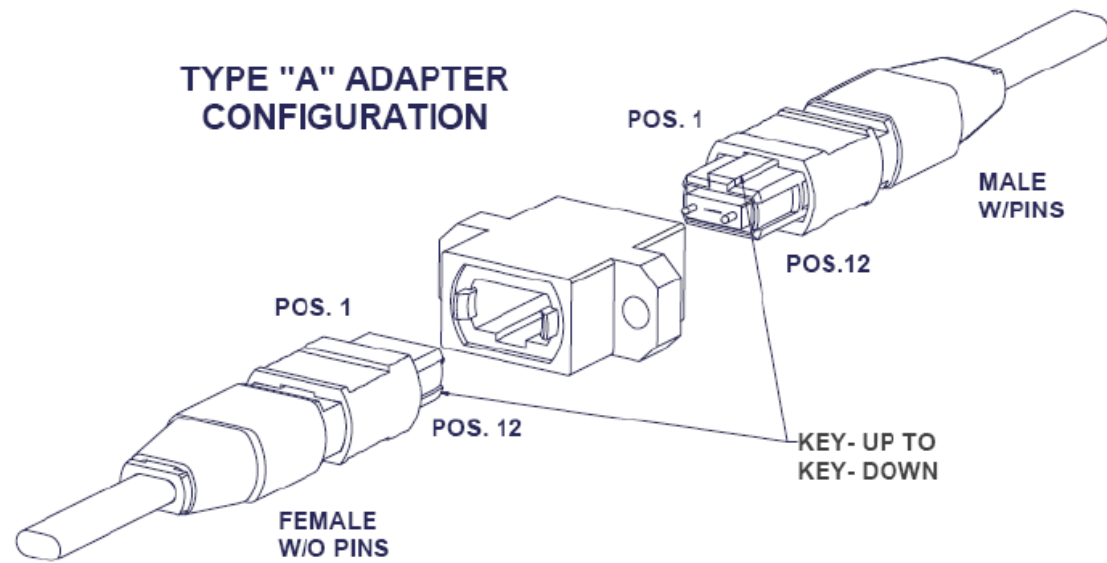

TYPE "B" ADAPTER CONFIGURATION

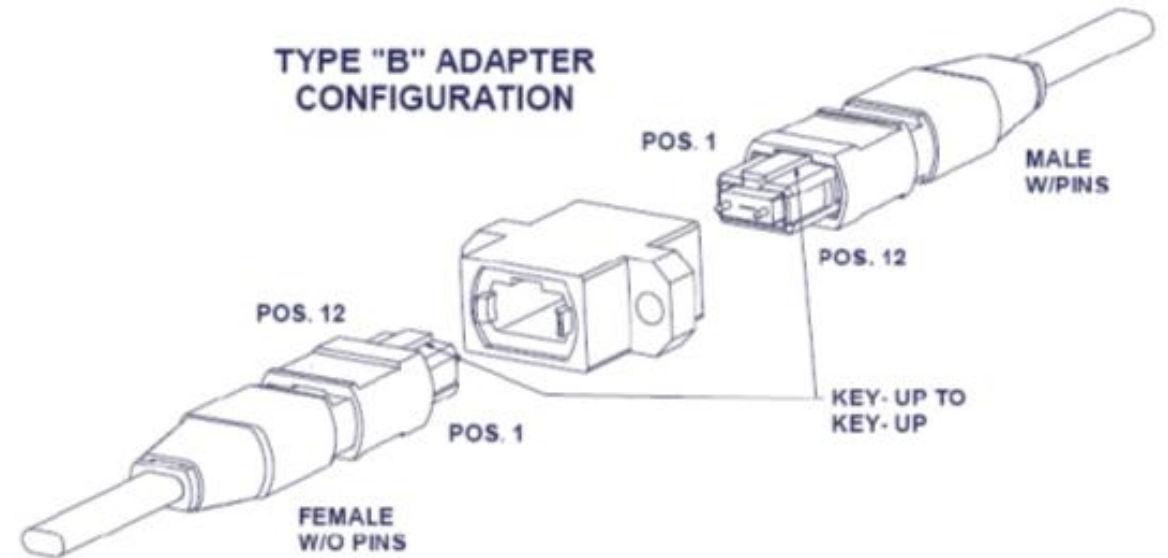



MPO Patch Cord Configurations

Type A Cable



1 2 3 4 5 6 7 8 9 10 11 12

1 2 3 4 5 6 7 8 9 10 11 12

Connector A: 1 2 3 4 5 6 7 8 9 10 11 12
Connector B: 1 2 3 4 5 6 7 8 9 10 11 12

Type B Cable



1 2 3 4 5 6 7 8 9 10 11 12

1 2 3 4 5 6 7 8 9 10 11 12

Connector A: 1 2 3 4 5 6 7 8 9 10 11 12
Connector B: 12 11 10 9 8 7 6 5 4 3 2 1

Type C Cable

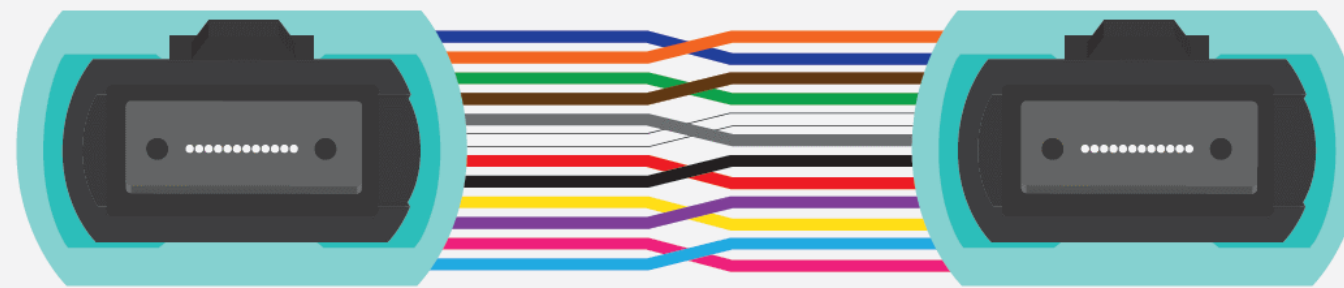

1 2 3 4 5 6 7 8 9 10 11 12

1 2 3 4 5 6 7 8 9 10 11 12

Connector A: 1 2 3 4 5 6 7 8 9 10 11 12
Connector B: 2 1 4 3 6 5 8 7 10 9 12 11



Focus on the Connection

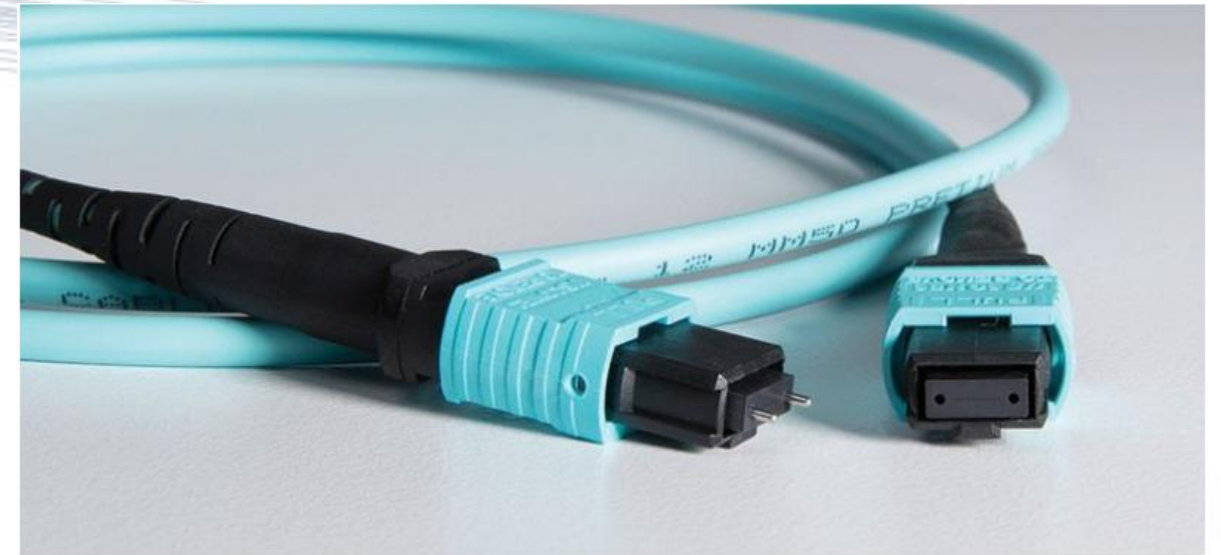
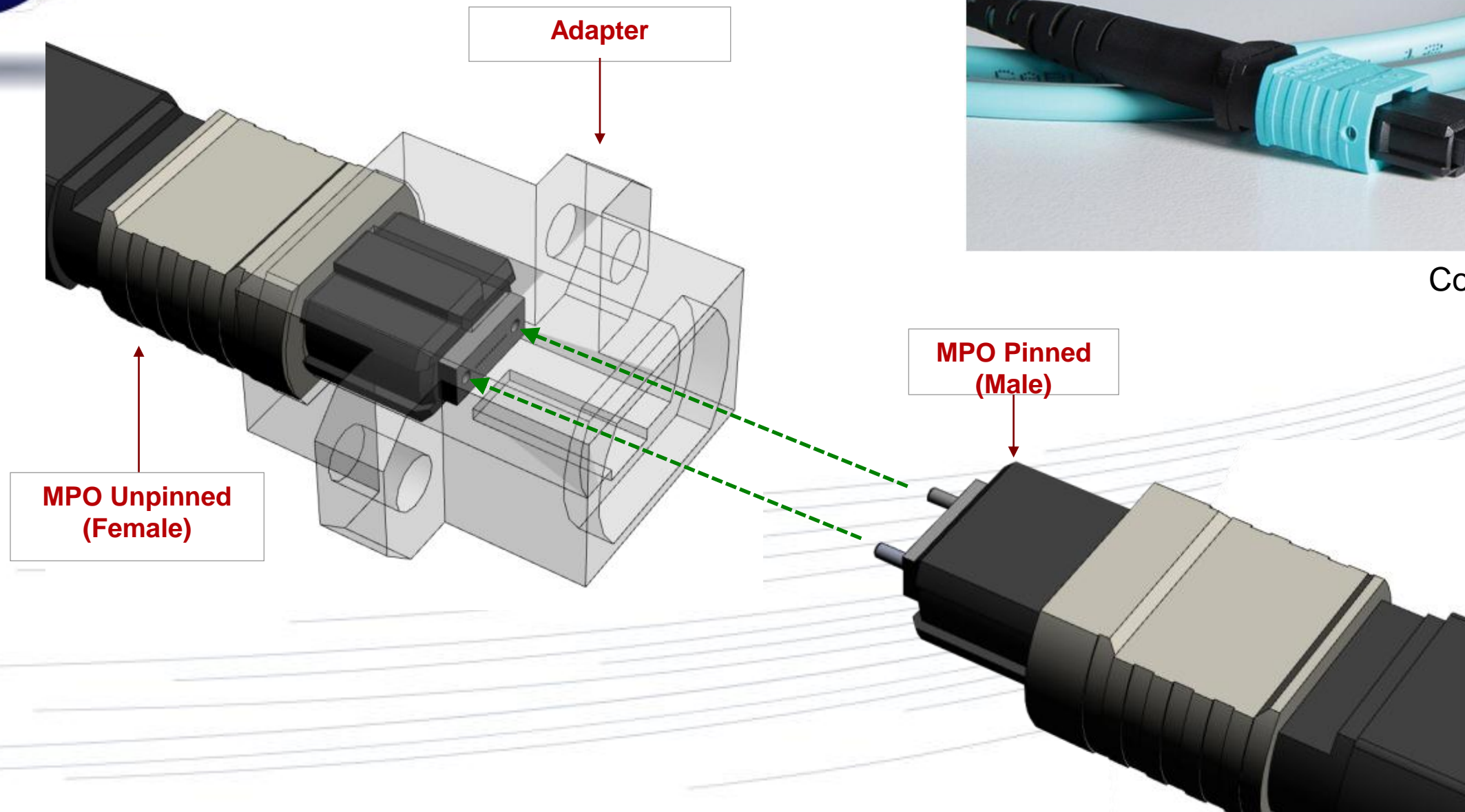

Courtesy of US Connec



Focus on the Connection

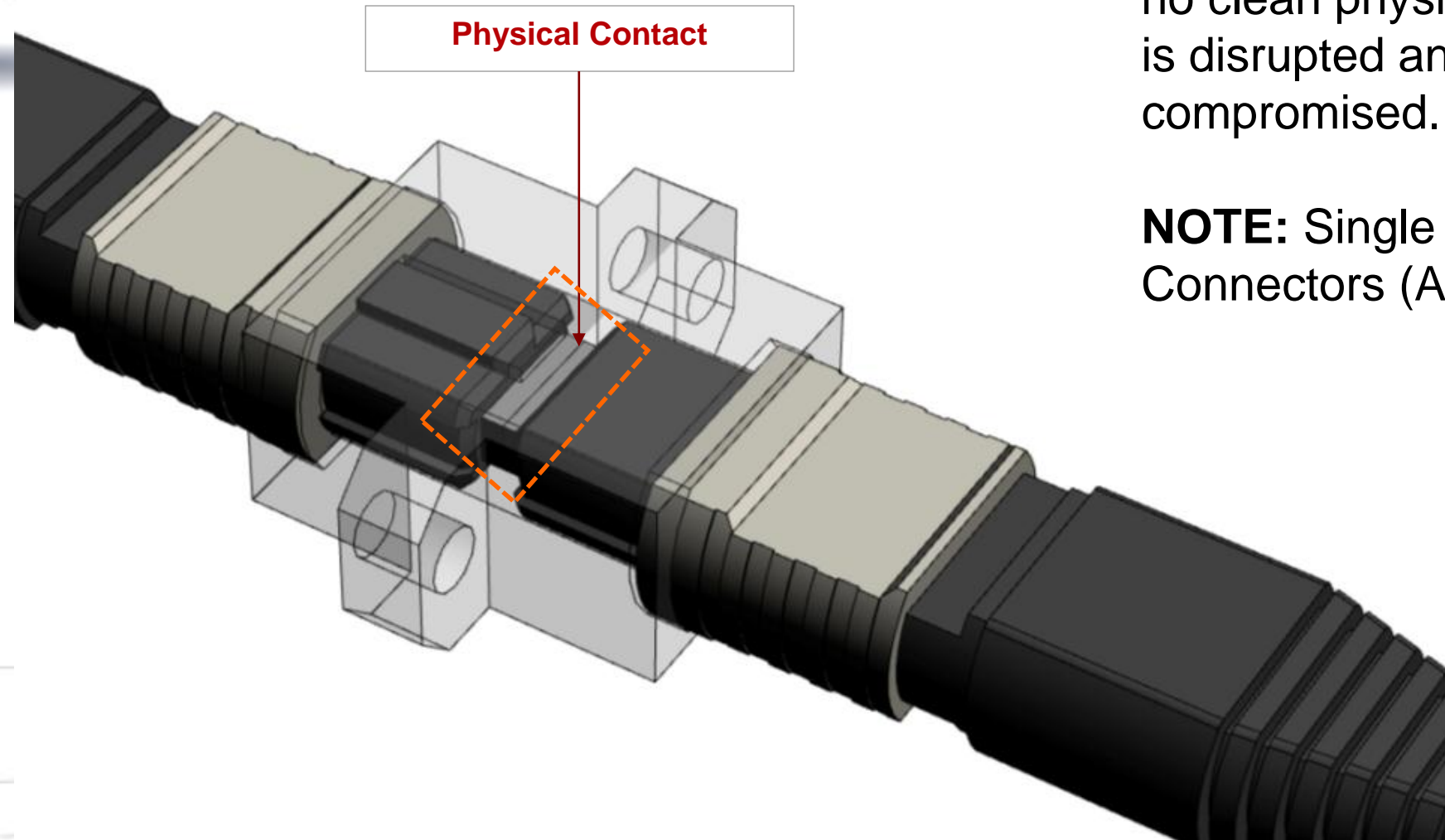

The **Physical Contact** area is the critical joining point in the fiber network. If there is no clean physical connection, the light path is disrupted and the connection is compromised.

NOTE: Single mode uses Angled Polished Connectors (APC). Multimode uses PC.

Top-View Cross Section of 12 Fiber MPO

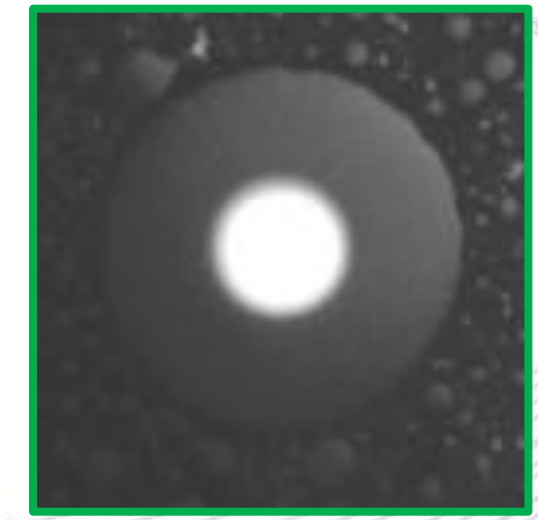
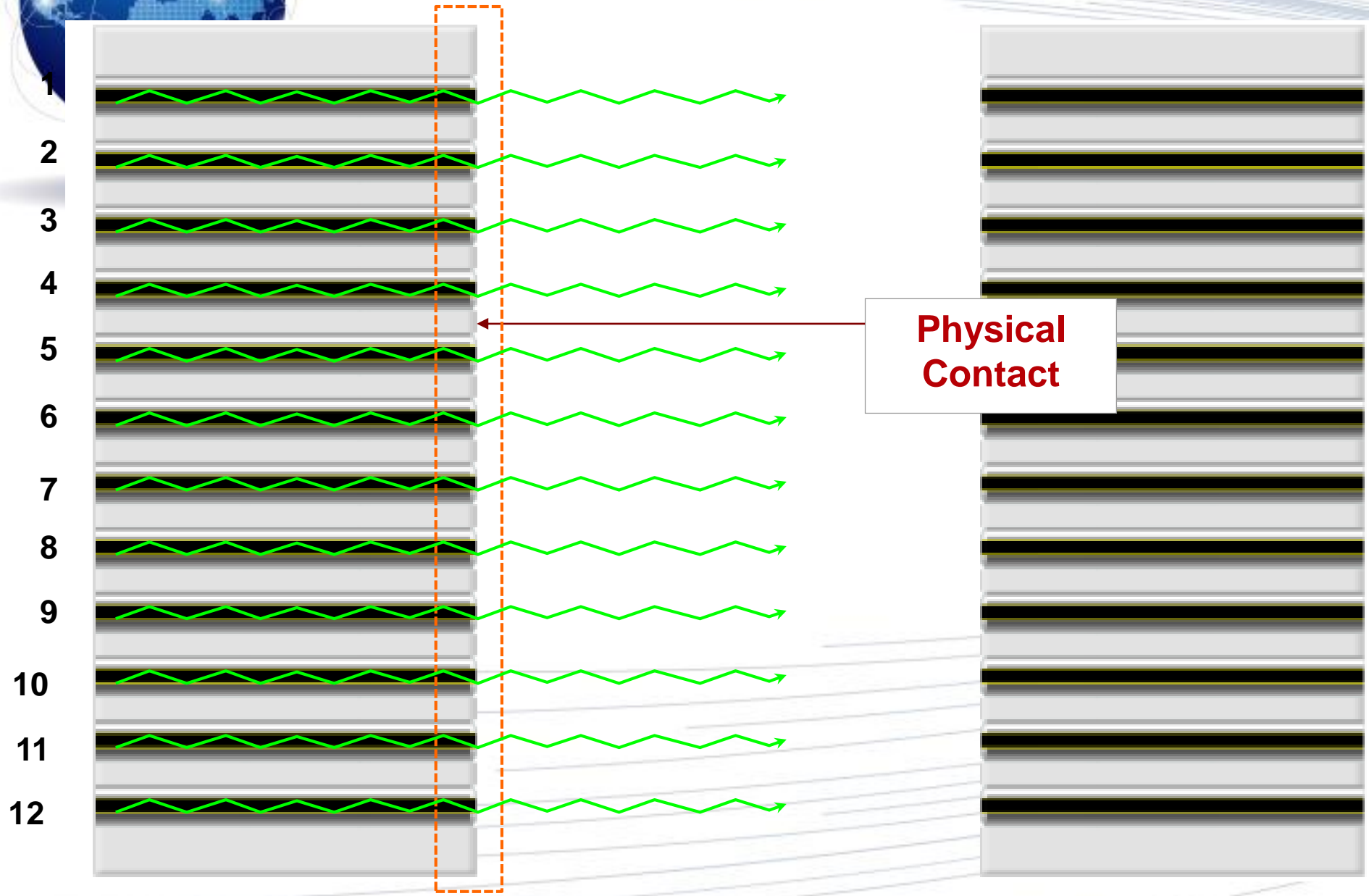

Clean

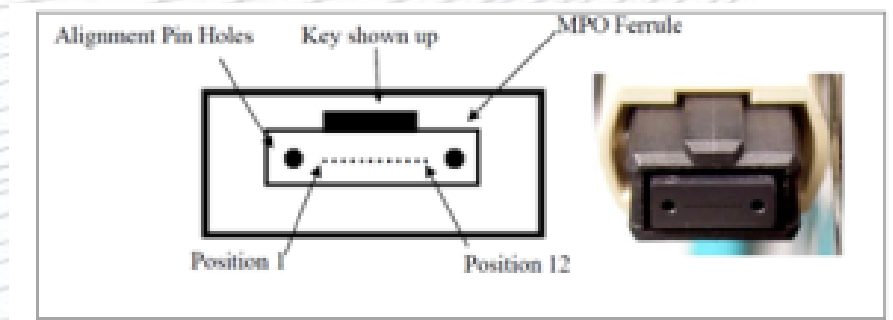

MPO Front View



Top-View Cross Section of 12 Fiber MPO

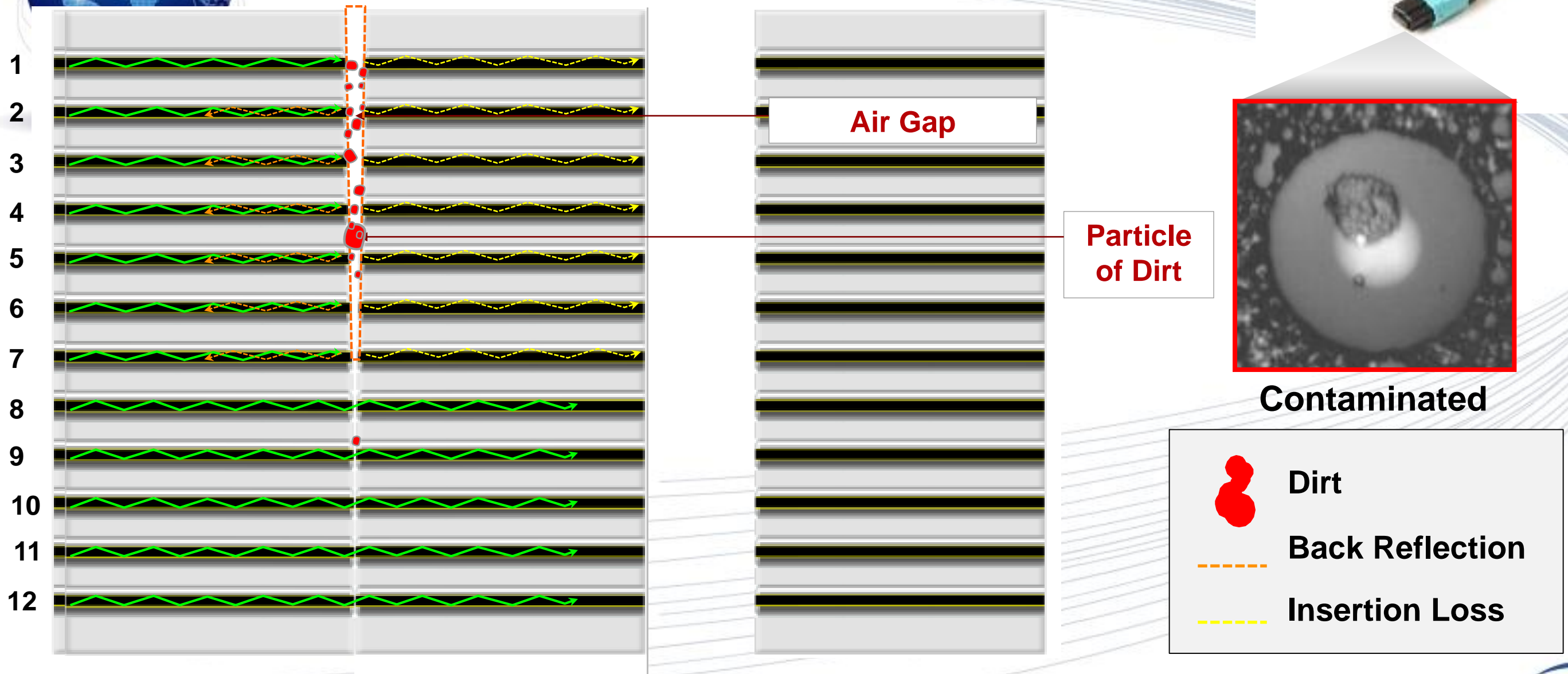



Impact of MPO contamination

If a critical connection is affected, the impact can be exponential!

Front = Simplex



Back = MPO

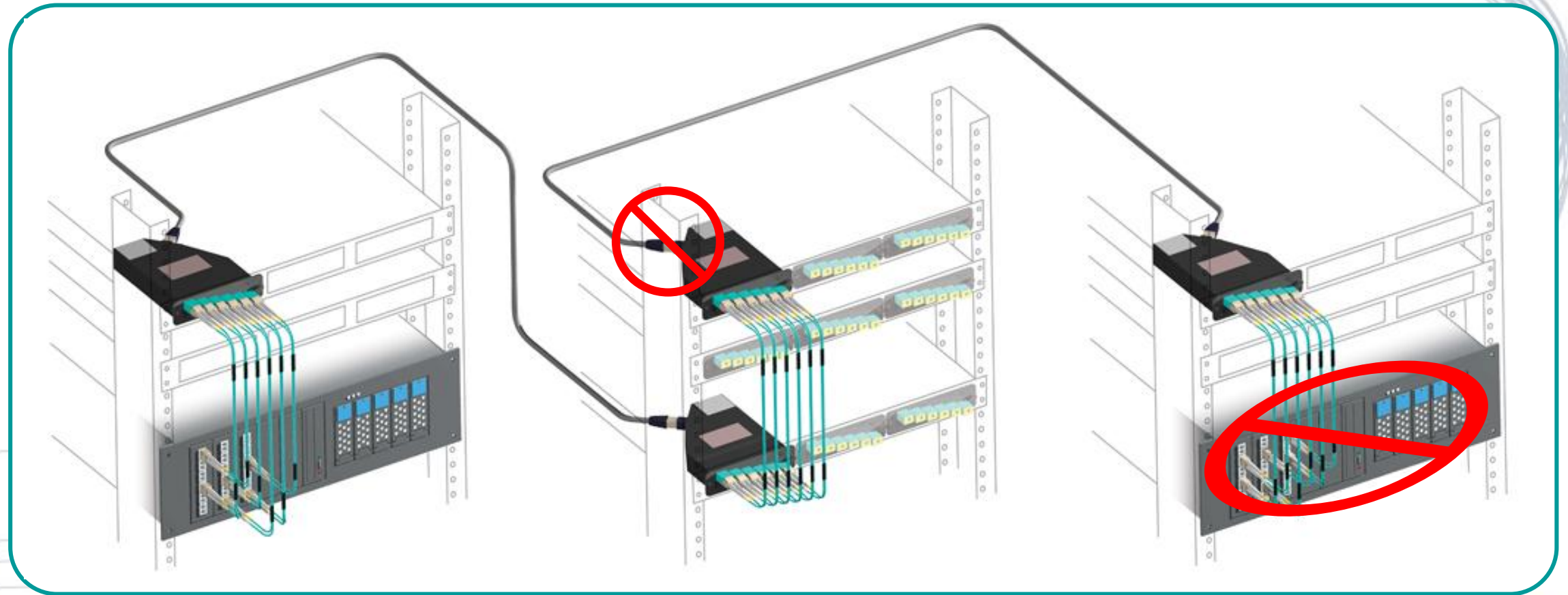
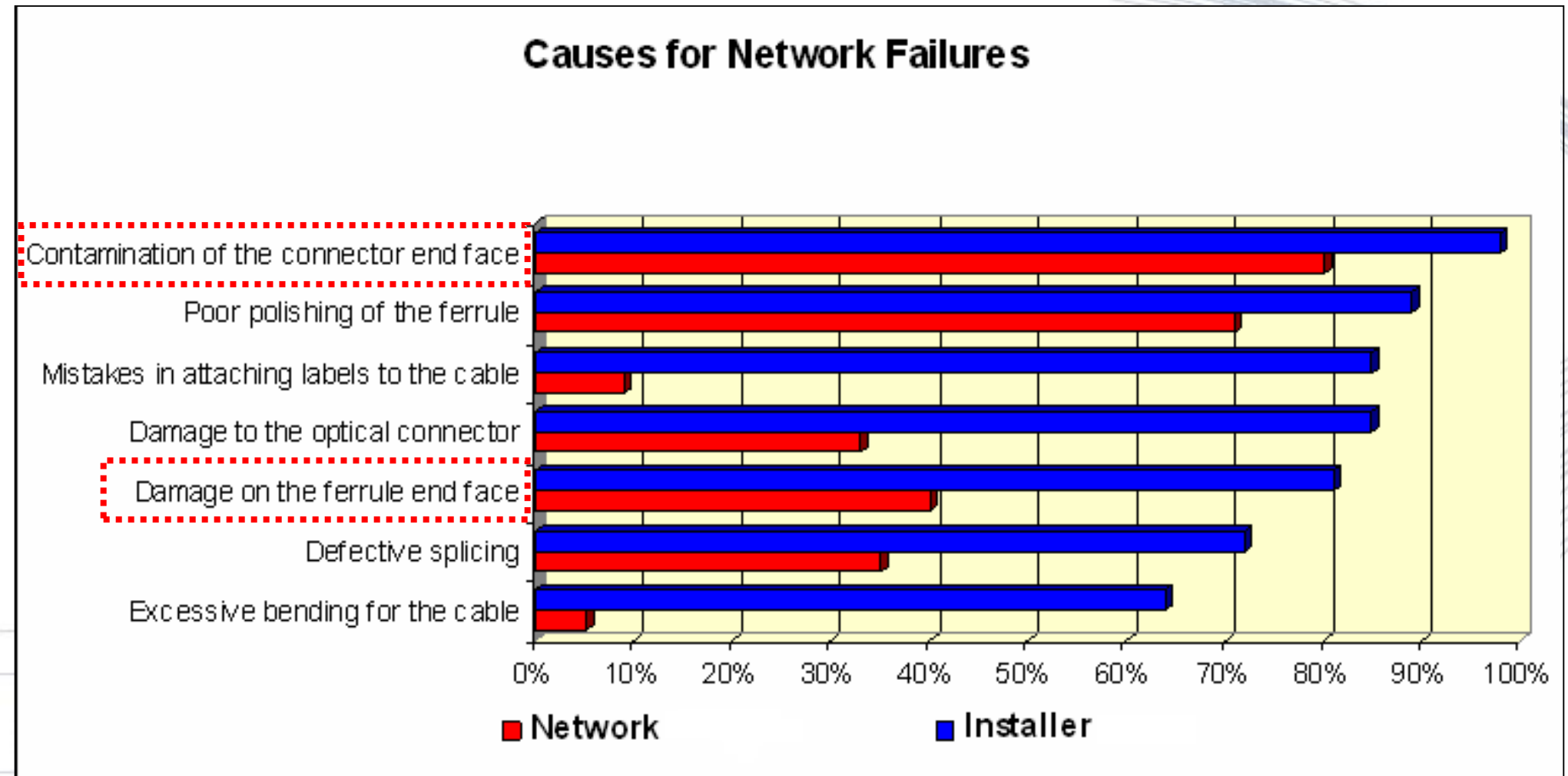

Image property of CommScope



Contaminated fiber end-face is the #1 cause of network failures



In a study by NTT-Advanced Technology, 98% of installers (blue) and 80% of network owners (red) reported that issues with connector contamination was the greatest cause of network failure.



Real End-Faces Examples

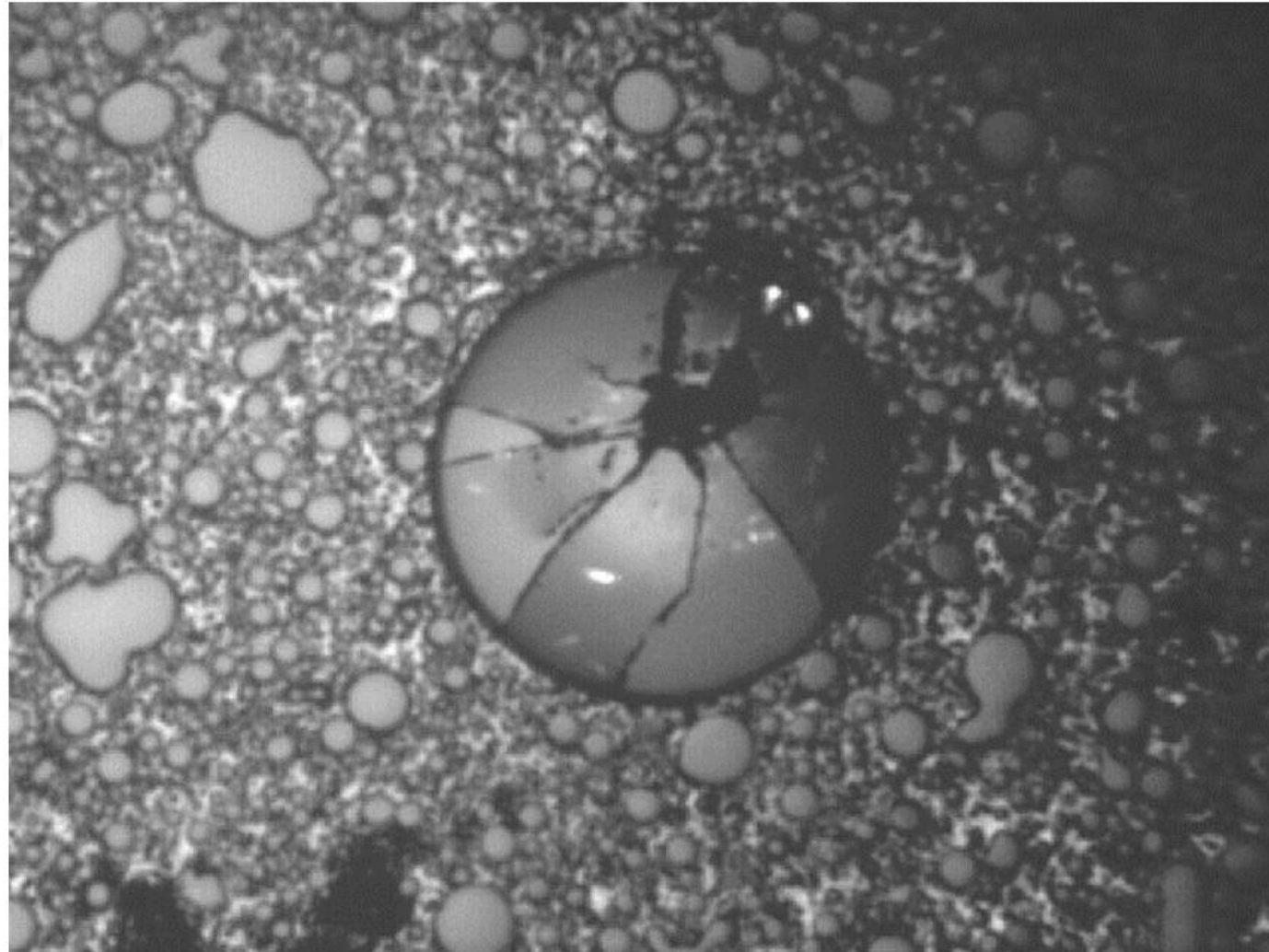

Cracked MPO

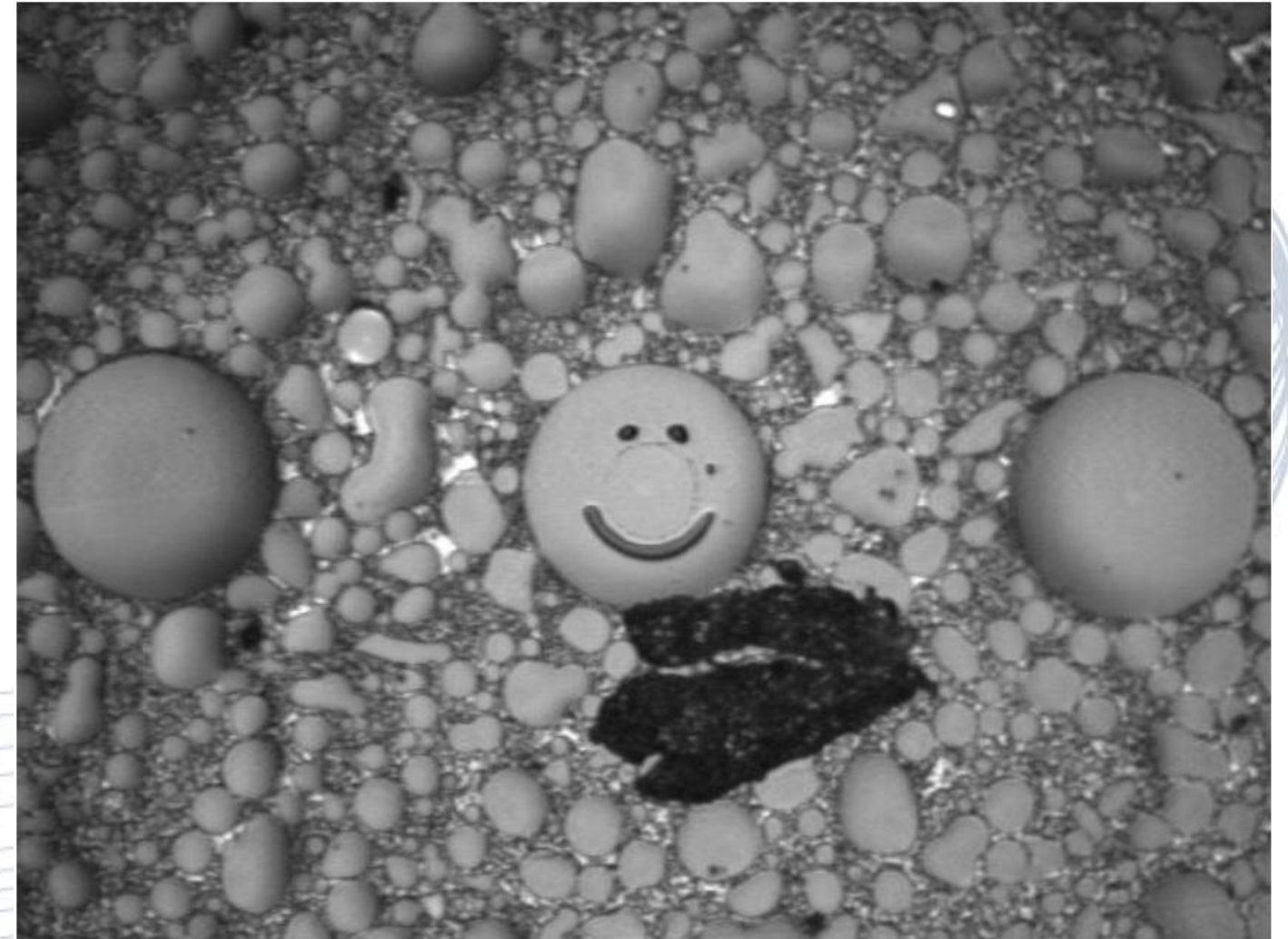

Happy MPO



TEST & CERTIFICATION





IEC Standards Related to Fibre Testing

SC 25 WG 3

ISO 11801

Information technology -
Generic cabling for
customer premises

ISO 14763-3

Information technology -
Implementation and operation of
customer premises cabling - Part 3:
Testing of optical fibre cabling

SC 86C WG 1

Test Procedures

IEC 61280-4-1

Installed cable plant -
Multimode attenuation
measurement

IEC 61280-4-2

Installed cable plant -
Single-mode attenuation
and optical return loss
measurement

IEC 61280-1-4

General
communication
subsystems - Light
source encircled flux
measurement method

IEC 61300-3-35

Visual inspection of
fibre optic connectors
and fibre-stub
transceivers



TIA Standards Related to Fiber Testing

- **568.3-D** – Optical fiber cabling and component standard
 - Updated to revision “D” in October 2016
 - Transmission performance and test requirements in Clause 7
 - Annex E (informative) provided guidelines for field testing
- **ANSI/TIA-526-14-C-2015**
 - Test procedures for installed multimode fiber cable plant
 - Released in April 2015
 - Adaptation of IEC 61280-4-1 Ed. 2.0
 - Encircled Flux for 850nm/50 micron
- **ANSI/TIA-526-7-A**
 - Test procedure for installed single mode fiber cable plant
 - Released in July 2015
 - Adoption of IEC 61280-4-2 Ed 2.0



Tests Defined in Standards

- Both TIA and ISO/IEC standards specify two tiers of certification
 - Tier 1 (or basic): loss, length, and polarity
 - Tier 2 (or extended): Optical time domain reflectometer (OTDR)
- Tier 2 (extended) tests are an optional addition to tier 1 (basic) tests
- Fiber end-face inspection and certification is also a requirement to ensure pristine end-face condition PRIOR to mating



Simple/Duplex vs MPO testing

- Existing fiber test standards do not address MPO-specific concerns
- SC 86C WG 1 has published a Technical Report (TR) on testing MPO

IEC 61282-15/TR

Testing Multi-fiber optic cable plant terminated with MPO connectors

Cabling testing standards such as IEC 61280-4-1 for multimode attenuation measurements and IEC 61280-4-2 for single-mode attenuation and optical return loss measurement describe testing simplex or duplex fibre cabling terminated with single-fibre ferrule connectors. These IEC standards are difficult to apply to the testing of installed multi-fibre cabling terminated with multi-fibre connectors (MPO).



Challenges for testing MPO

- End-face condition at ALL connection points
- When to test MPO vs. duplex/simplex
- Fiber map (polarity)
- Gender (pinned/unpinned) and its impact on reference methods and types of cables
- QSFP to LC connections
- Loss test vs. OTDR test



Data Center Examples of MPO/Ribbon Fiber

6 x 1/10Gbps Ethernet Channels (MMF)

6 x 1/10Gbps Ethernet Channels (SMF)

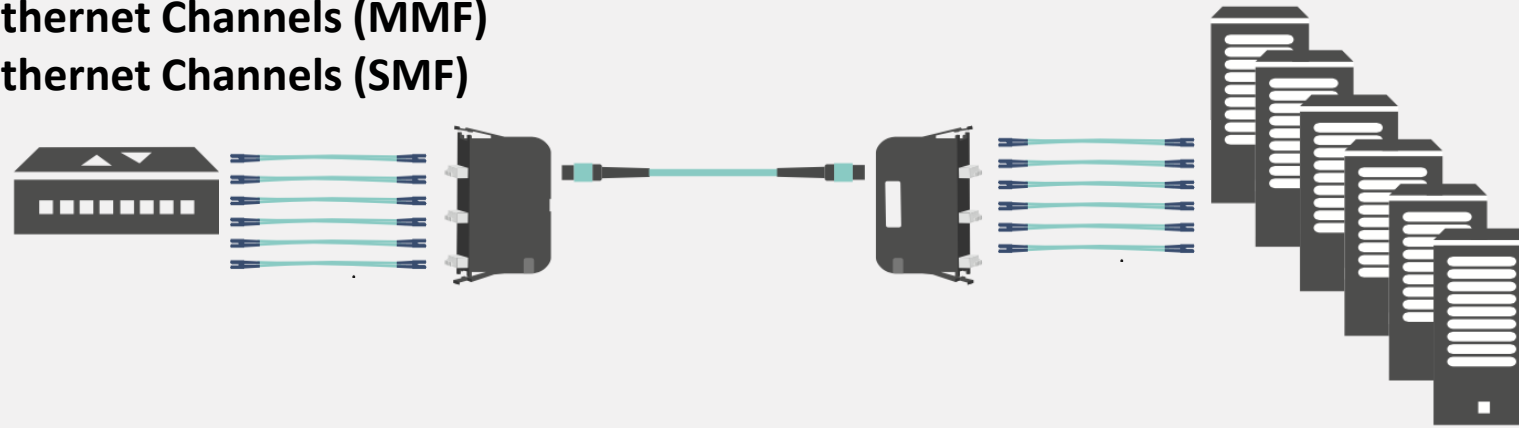

- Inspect MPO connection to cassettes
- Test duplex drops

4 x 10Gbps Ethernet Channels (MMF)

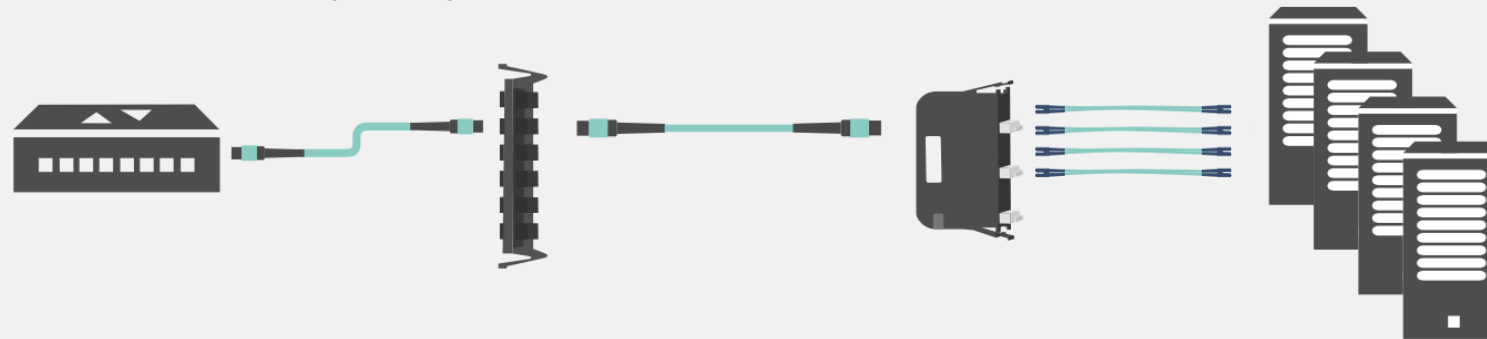

- Inspect MPO connection to cassettes and patch panels
- Test from MPO to simplex

40/100Gbps Ethernet Channels (MMF)

40/100Gbps Ethernet Channels (SMF – PSM4)

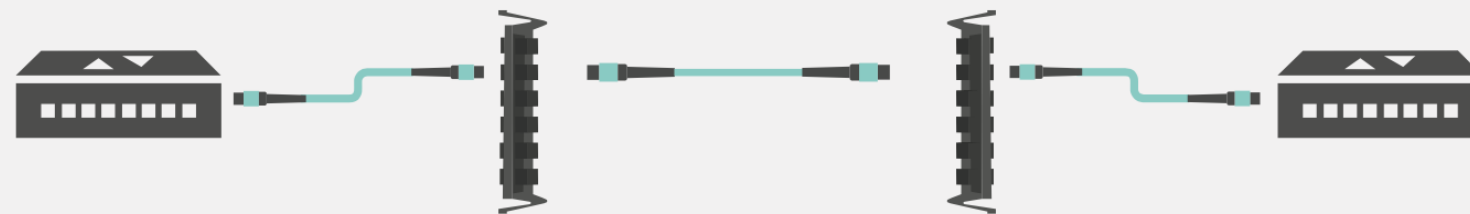

- Inspect MPO connection
- Test MPO Links/Channels



Inspect Before You ConnectSM

Follow this simple **“INSPECT BEFORE YOU CONNECT”** process to ensure fiber end faces are clean prior to mating connectors.

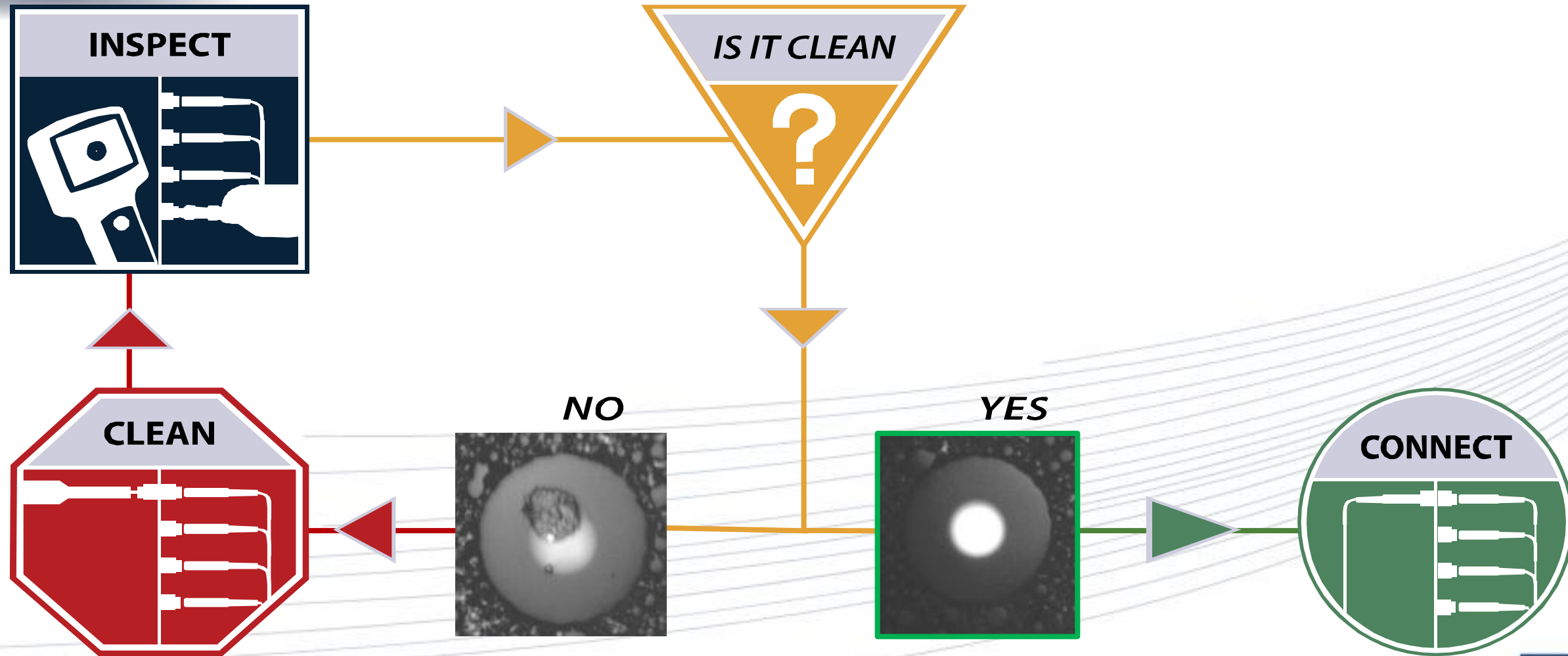



Inspect and Clean Both Connectors in Pair

Inspecting BOTH sides of the connection is the **ONLY WAY** to ensure that it will be free of contamination and defects.



Patch Cord (“Male”) Inspection



Bulkhead (“Female”) Inspection

Patch cords are easy to access and view compared to the fiber inside the bulkhead, which is frequently overlooked. The bulkhead side may only be half of the connection, but it is far more likely to be dirty and problematic.



Inspect ALL fibers in a Multi-Fiber Connector

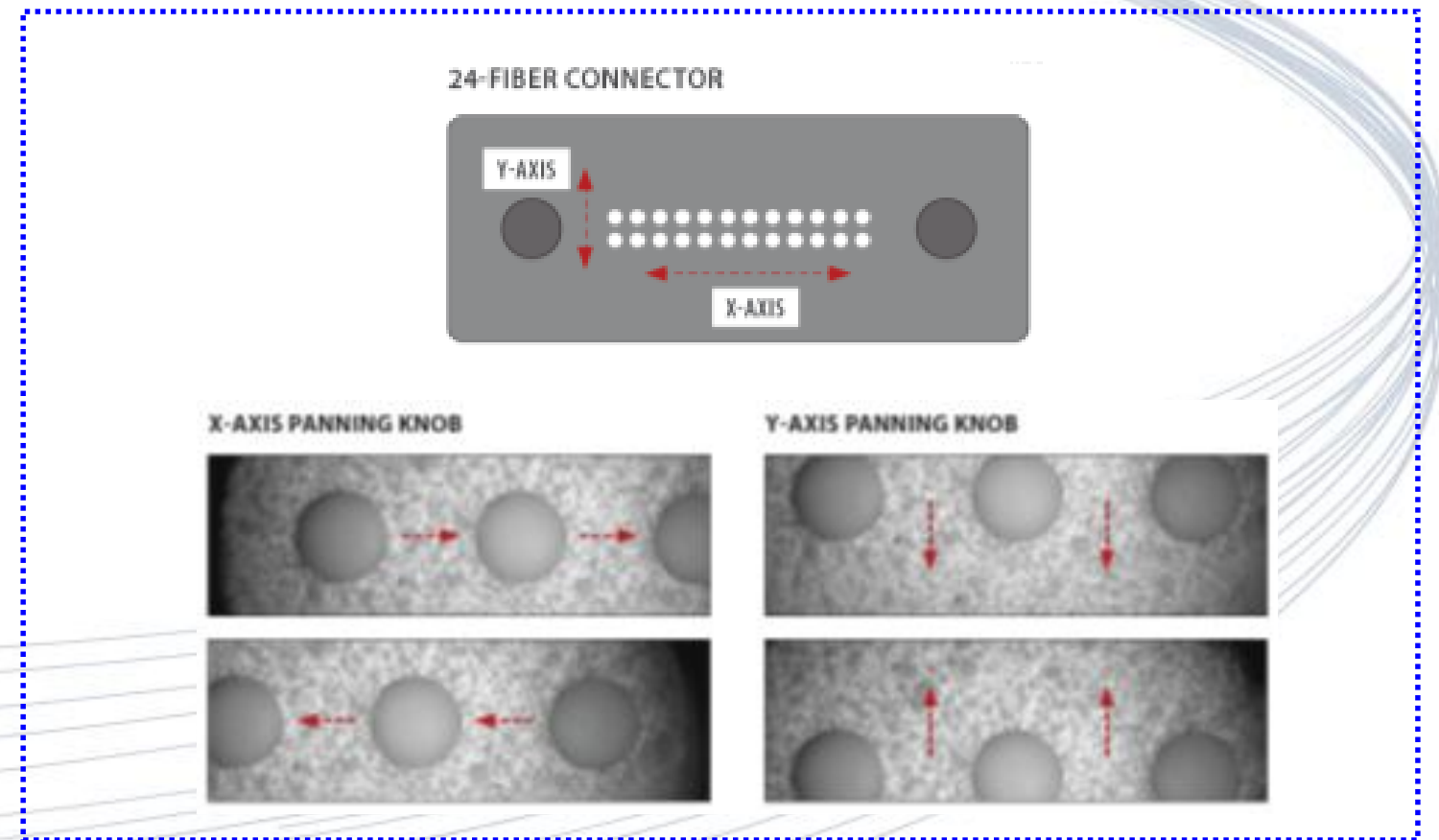

Patch cords are easy to access and view compared to the fiber inside the bulkhead, which is frequently overlooked. The bulkhead side may only be half of the connection, but it is far more likely to be dirty and problematic.



IEC 61300-3-35 Sets Requirements for Connector Quality

Even for MPO!

CLADDING Zone

CORE Zone

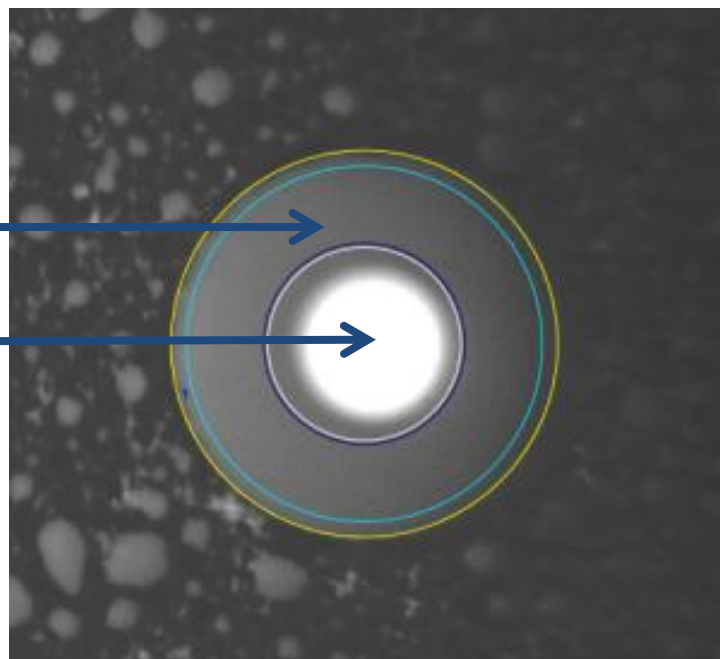

Multimode MPO Connectors

ZONE NAME (Diameter)	SCRATCHES	DEFECTS
A. CORE Zone (0–65µm)	no limit $\leq 5\mu\text{m}$ 0 $> 5\mu\text{m}$	4 $\leq 5\mu\text{m}$ none $> 5\mu\text{m}$
B. CLADDING Zone (65–115µm)	no limit $\leq 5\mu\text{m}$ 0 $> 5\mu\text{m}$	no limit $< 2\mu\text{m}$ 5 from 2–5µm none $> 5\mu\text{m}$



Polarity Check (Fiber Map)

- For existing installations, the end-to-end polarity is often not known
- Fiber Map shows the polarity of the system

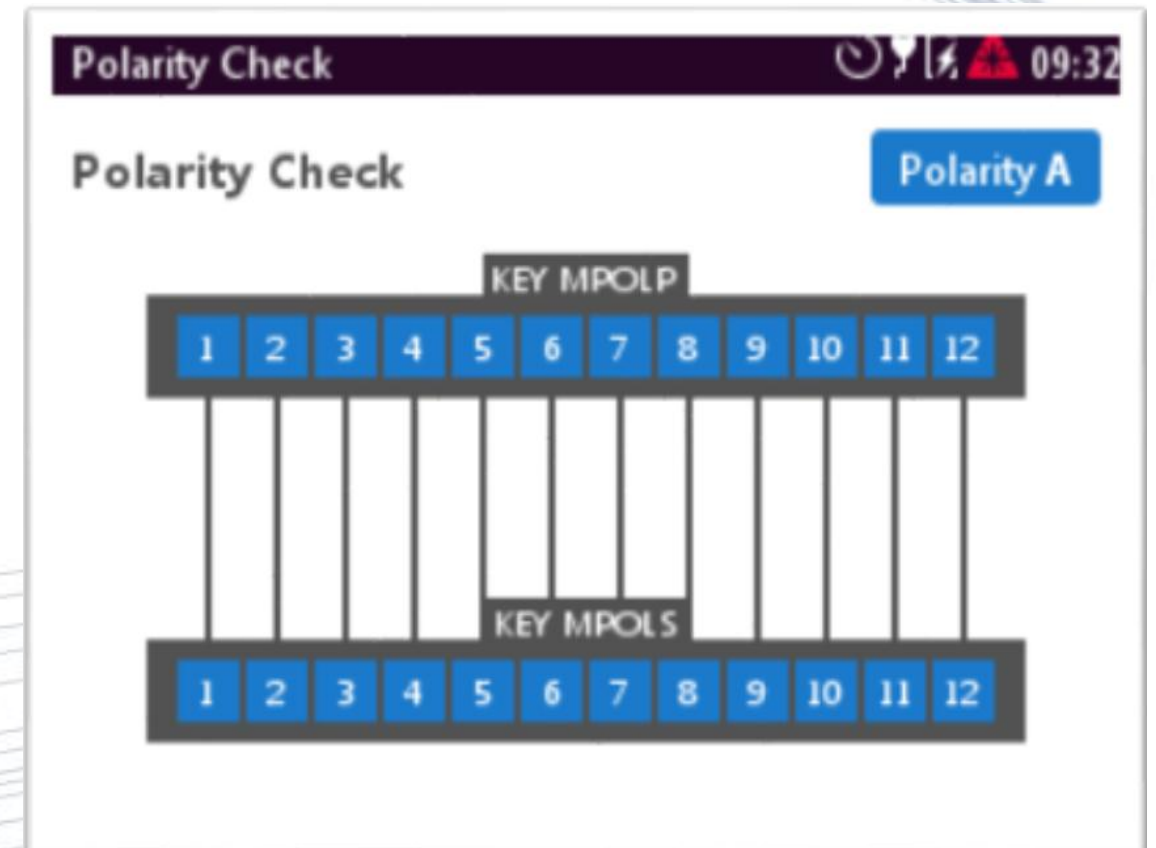



Tier 1 (Basic) MPO to MPO Certification

- Test Links and Channels
- Loss, Length and Polarity

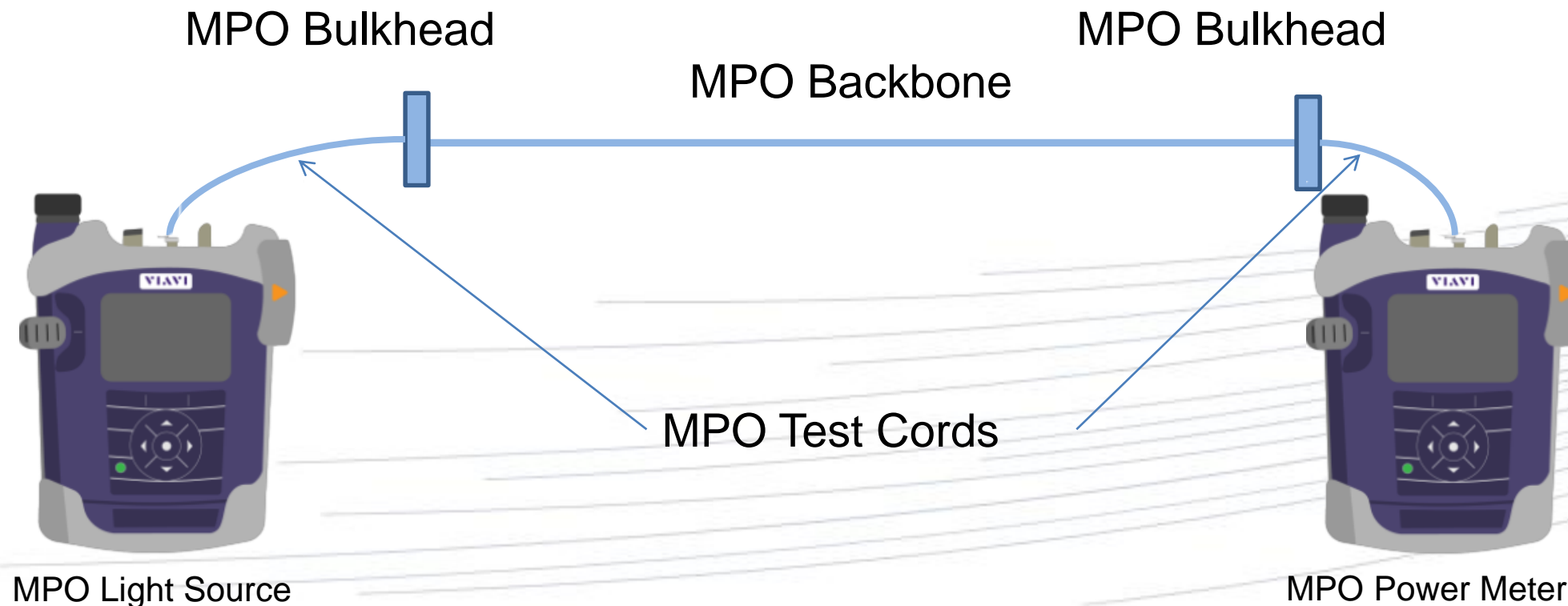
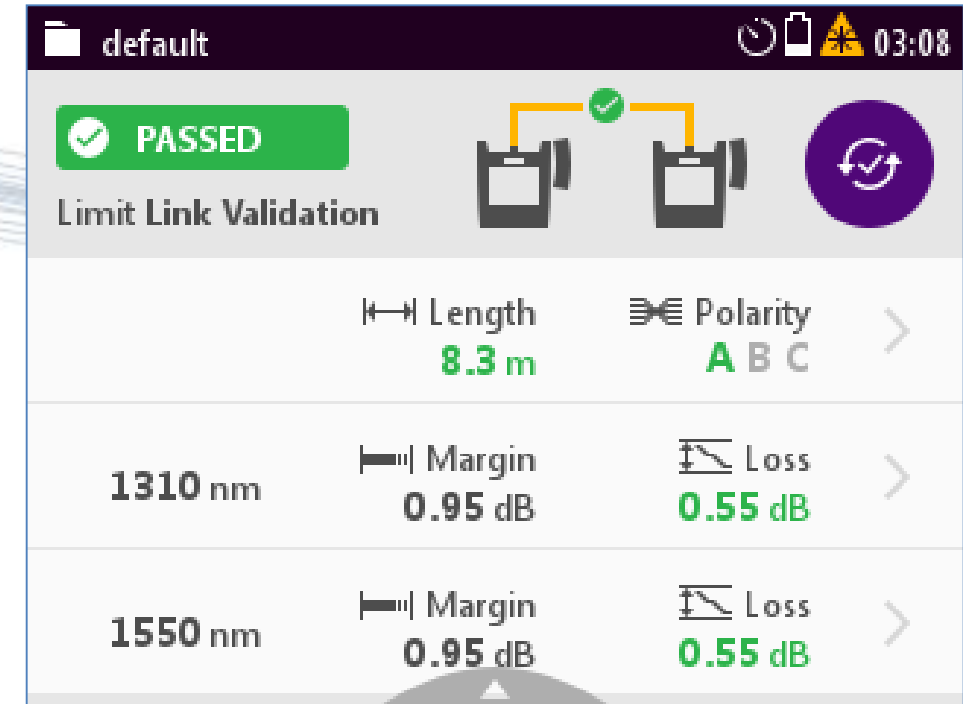

default 03:09

Loss Limit **1.5 dB**

Pol.	Fib.	Margin	Loss	Fib.	Margin	Loss
1310	1	0.95	0.55	7	1.24	0.26
	2	1.03	0.47	8	1.22	0.28
	3	1.04	0.46	9	1.16	0.34
	4	0.99	0.51	10	1.16	0.34
1550	5	1.32	0.18	11	1.27	0.23
	6	1.28	0.22	12	1.22	0.28



MPO Power Meter

- MPO power meter – Using any MPO source
 - Fault Isolation
 - Testing output power from 40G optics

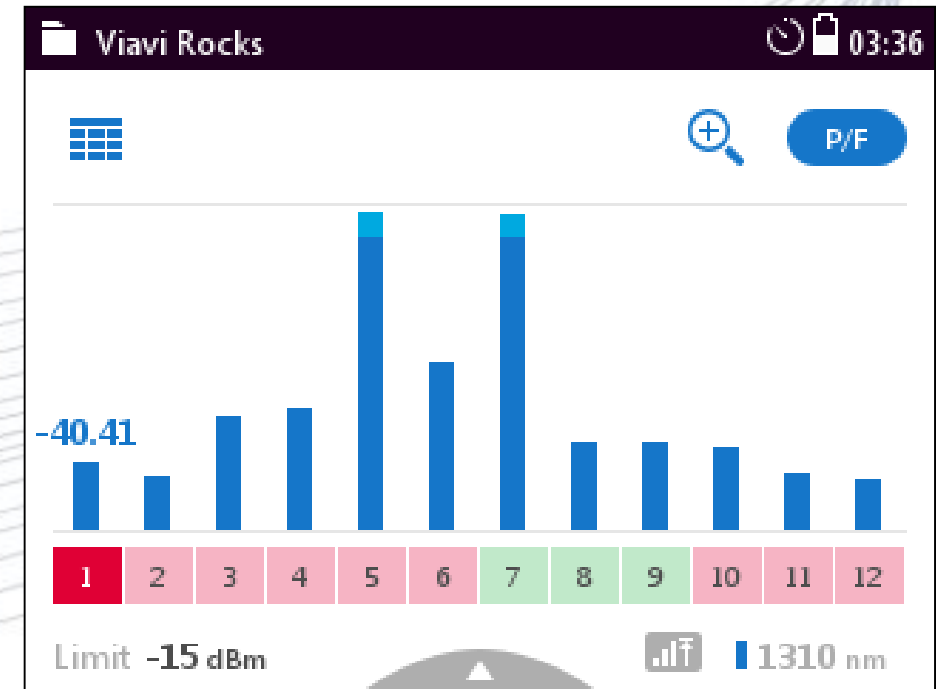
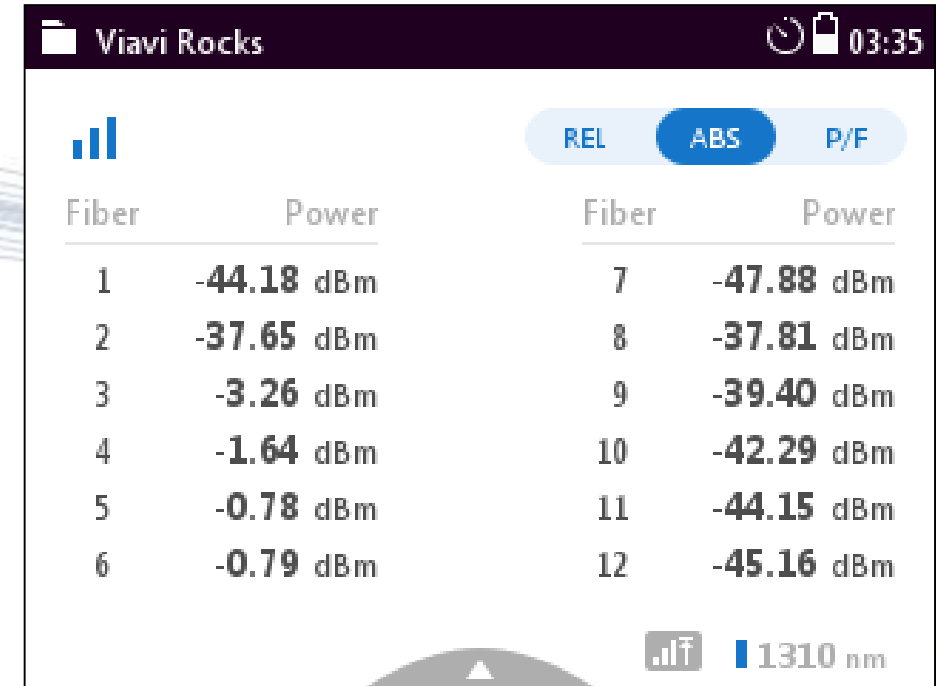
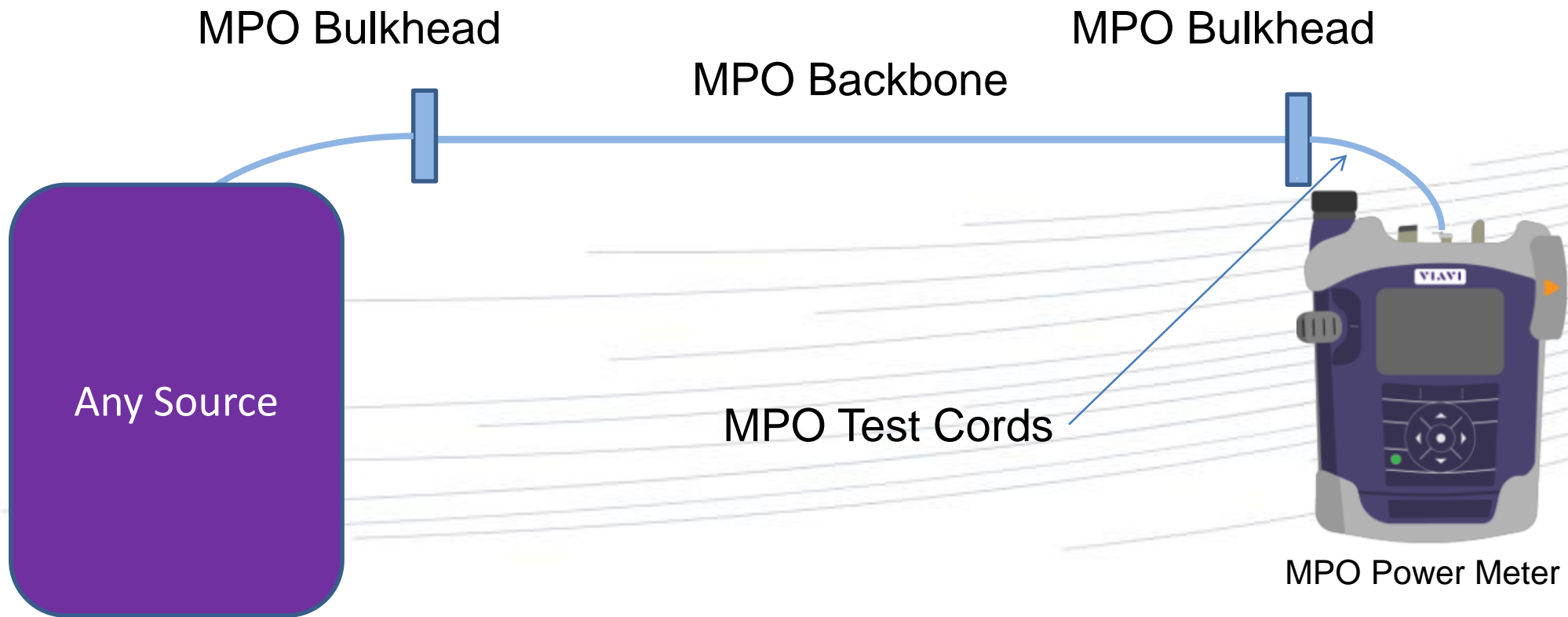



Selecting Channels

- Can apply to any of the above Test scenarios
- Helps in cases when 8 or fewer fibers are present in MPO links (e.g. 40GBASE-SR4)
- Allows selection of which of the 12 channels are active
 - At the Remote (TX) and at the Local (RX)
- Results reflect topology
- No unwanted “fails” due to nonexistent channels

MPO L/L ... > Generic MM Config  09:23 AM

Please select the fibers for pass/fail testing.

1 ✓	2 ✓	3 ✓	4 ✓	5	6
7	8	9 ✓	10 ✓	11 ✓	12 ✓

 Pass/Fail enabled

DONE



Tier 2 (Extended) Testing of MPO

- Tier 1 testing cannot ensure individual event (splices and connection) losses are within spec OR the cable attenuation is uniform
- Tier 2 (OTDR) testing adds the characterization of these events to the certification test
- Tier 2 testing is also the ideal fiber troubleshooting tool to find the cause AND location of excess loss (incl. breaks) and reflectance for eg. if you fail in Tier 1
- Requires MPO switch
- Pinned/unpinned systems require different launch and receive cords



MPO OTDR Testing (via MPO Switch)



MPOx12 Launch Lead

★ Connector endface inspection test points

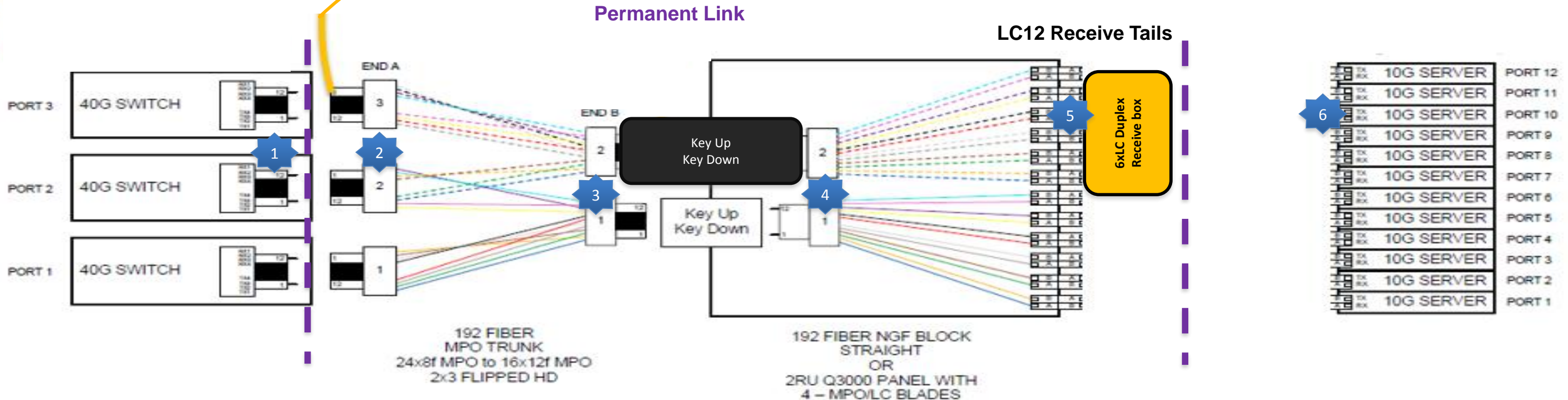



Schematic test results (pass example)

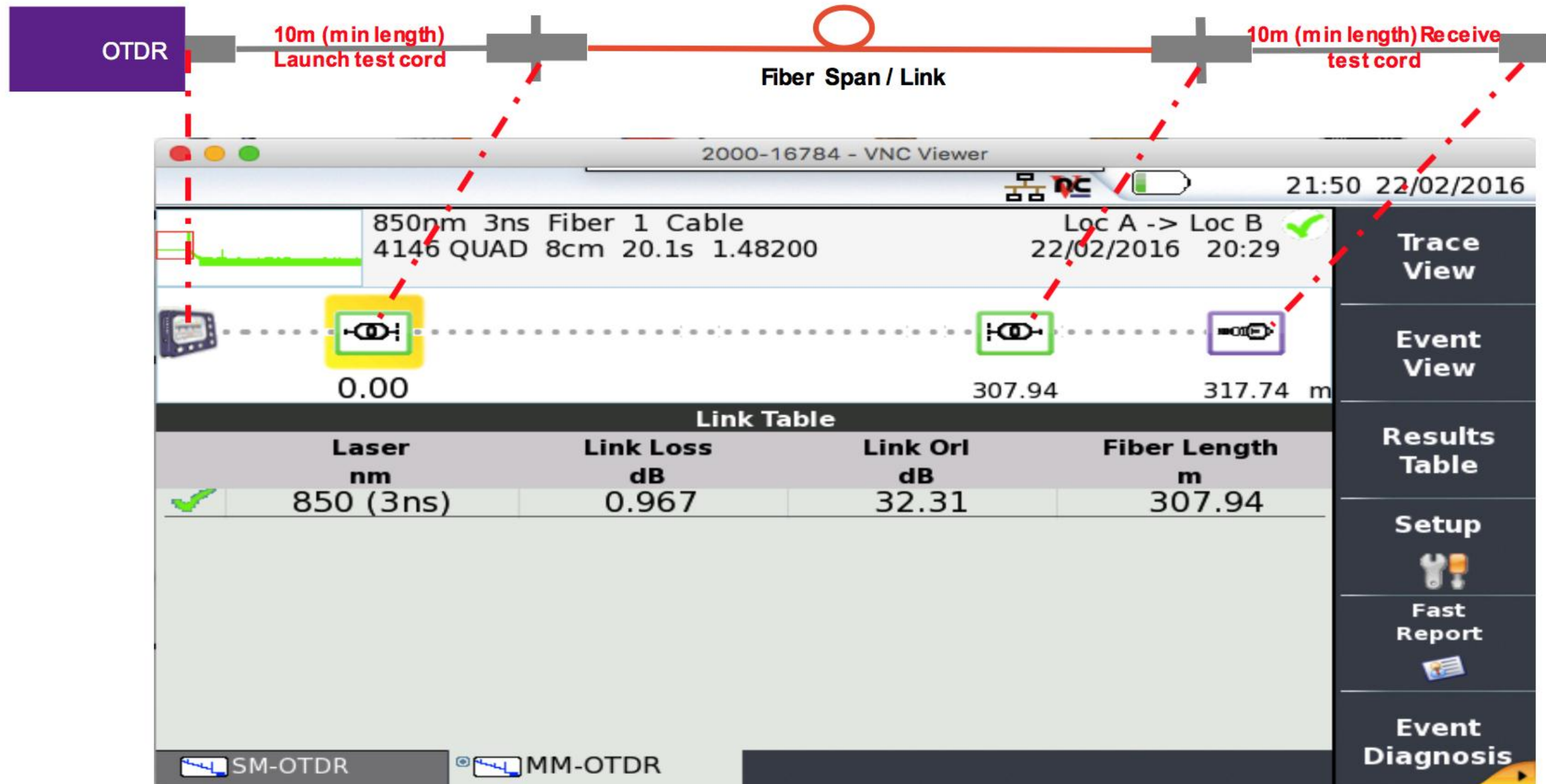



Wrap-up

- **MPO end-face condition is the most critical element in a channel with MPO connections**
- **Polarity can be a challenge – especially when adapting existing MPO backbones to new services**
- **Be aware of pinned/unpinned – presents challenges for testing (test cords must mate with system – challenges with test device and test cord gender)**
- **Loss testing is typically done on links**
 - **1/10G MM, 1/10/40/100G SM link is duplex**
 - **40/100G MM, PSM4 SM link is MPO**
- **Testing channels may make sense if hydra (fan cables) are used**
- **OTDR testing of MPO allows for:**
 - **Characterization of the link or channel (uniformity of cable attenuation and connection loss)**
 - **Fault isolation to prevent unnecessary service interruptions**
 - **Length measurements**



Thank you